

Cord Drawn Drapery Track System Silent Gliss® 6350

6351

1:1

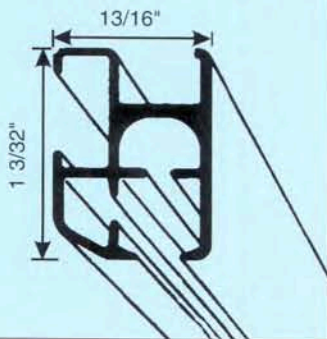

Product Information

- #6350 is a medium to heavy duty cord drawn drapery system
- Accommodates Pinch Pleat, S-fold or Z-fold drapery headings (see section "appendix" for additional S/Z-fold information)
- Enclosed cord channels ensure that the cord can not slip out of the system
- Available in standard clear anodized or optional white painted finish
- System up to 30'
- System can be curved or bent on both inside and outside radii
- Easy wall, ceiling, suspended or recessed mounting possibilities
- Particularly suitable for:
 - Offices
 - Hotels/Motels
 - Hospitals
 - Schools
 - Homes
- 5 Year Warranty

Bending & Stacking Possibilities

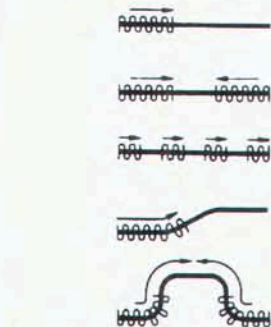

Can be bent
Min. radius R
6351 = 8"

Installation

Ceiling Mount

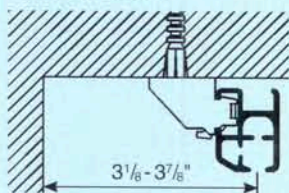

Brackets may be pre-installed and system snapped onto brackets OR brackets may be attached onto tracks and entire system mounted to ceiling.

To remove system from brackets use a screw driver to release the track and remove in an upward motion (opposite to the mounting of the track)

Wall Mount

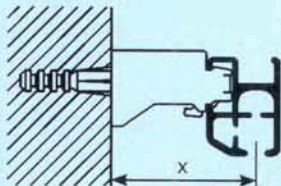

Wall support	X
3630	1 1/2"
3660	2 1/4"

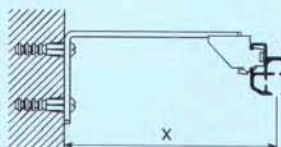

Bracket	X
0829	2-3 1/2"
0831	3 3/4-4 7/8"
0829+0828	3 3/8-5 1/4"
0831+0828	5 1/4-6 3/8"

Use #0829 + #0831 extension brackets with #3603 ceiling bracket for various projections from wall.

Profile Mounting

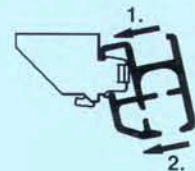

Profile Unmounting

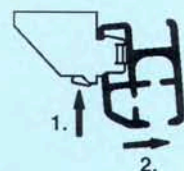

Recessed Mount



With Recess Profile #2732 and Clamp Bar #2733. (Available In White Only)

Standard Components

6358 Pulley Set



6355/6356
Cord guide
returns

6354
pilot runner X 2

3603
Ceiling
Bracket

6086
Spring Stop

6065
Endstop

6098
Roller
with eye

3093
Heavy Duty
Cord

6063
Overlap Arm

Optional Components

0829
2 3/4"
Wall Extension
Bracket

3660
Wall Bracket

6083
Glider

6283
Roller

6094
Roller
with hook

S-fold/Z-fold
components
refer to
section
"appendix"

0831
4.0"
Wall Extension
Bracket

3630
Wall Bracket

3020
Hook

3075
Free hanging
cord weight

6575
Cord
Tensioner



6350