

Heavy Duty and Stage Curtain Track System Silent Gliss® 6370

Specification guide

Silent Gliss 6370 curtain track, cord operated, assembled complete with roller gliders 6098 at 10/m, cord 6070 with cord drop 3000mm right-hand side), ceiling fixed through profile at 500mm centres plus endpieces, each once

screwed to timber/plugged and screwed to brickwork/concrete.

..... Lm. in lengths.

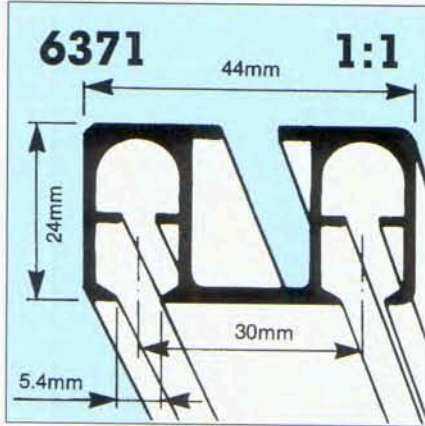

Fitting

Direct to ceiling fixing through profile

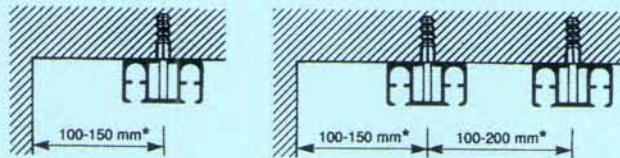

Fix at approximately 500mm centres plus endpieces.

Wall mounting with extension brackets 3239

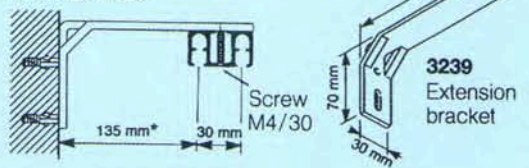

Recessed fixing

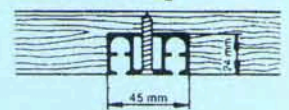

*Dependent on curtain weight, and any obstructions

Product Information

- Discreet heavy-duty track system with twin channel for infinite overlap.
- Cost effective system for small stages, very heavy contract and domestic use, etc.
- Heavy curtains up to 70kg., and width up to 15m.
- Simple direct fixing, ceiling fix preferred. Drilled at approximately 500mm centres.
- Profile available in 4, 5 and 6 metre lengths.
- Satin silver finish as standard.
- Standard cord drop 300cm.

Standard Accessories

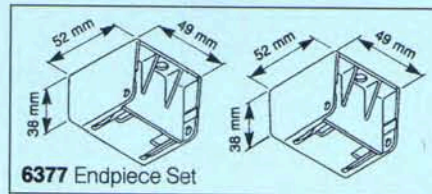

6377 Endpiece Set



6098 Roller glider with eye



6086 Spring stop



6227 Master runner



6214 Adjustable pilot



6070 Cord



1128C Screw

Optional Accessories



6094 Roller glider with hook



6007 Endstop



6283 Roller glider

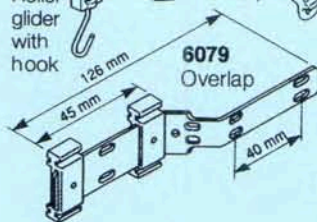

6079 Overlap

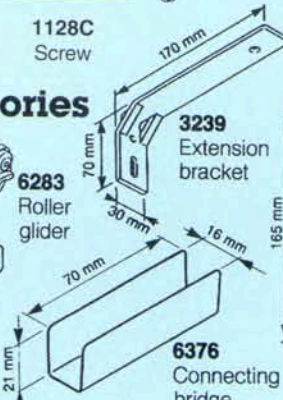

3239 Extension bracket

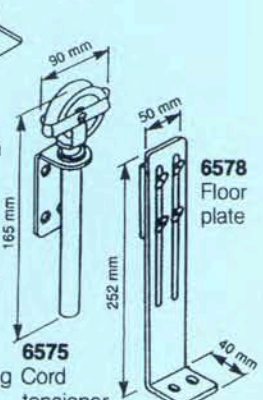

6575 Cord tensioner
6578 Floor plate

Max. Curtain Weights

	3m	6m	9m	12m	15m
	65	60	55	50	45
	70	68	64	57	50
	48	42	36	31	26
	54	48	42	36	30
	38	32	27	22	18
	44	38	32	27	22



Can be bent
Min. radius R
6371=500mm